

VALUE[®]

VALUE Creates Value

Making Your Job More Enjoyable

Clamp
Operating Instruction

VMC-1

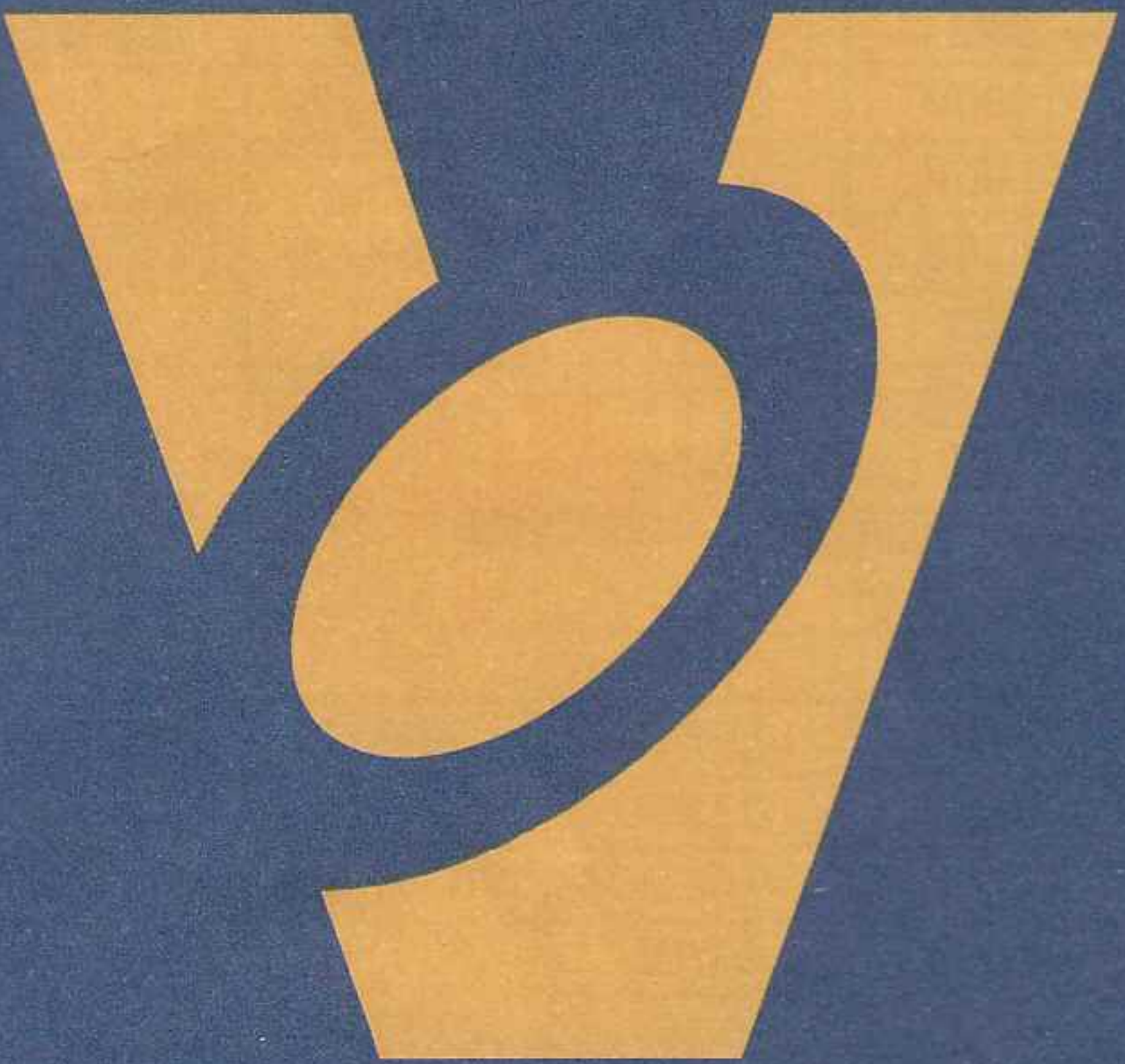

NAVTEK[™]
High-end Series

1. Introduction

VMC-1 series are 4000-count hand-held clamp meters with auto range. The meter is designed with ergonomic structure and overload protection for all ranges, which make it a superior tool for electricians. VMC-1 series can measure AC/DC voltage, AC current, resistance, diode, continuity, capacitance, temperature and perform data hold, max/min measurement, relative value measurement, NCV, low battery indication, audio/visual alarm and auto power off functions.

Please read the “safety guidelines” and “warnings” in this manual carefully before use and strictly observe the precautions.

Warning:

Please read the “safety guidelines” carefully before using the meter.

2. Open Box Inspection

Open the package box and take out the device. Please check whether the following items are deficient or damaged, and contact your supplier immediately if they are.

1) User manual	1pc
2) Test leads	1 pair
3) Type K temperature probe	1pc
4) Cloth bag	1pc
5) Certificate of approval	1pc

3. Safety Guidelines

Please pay attention to “”. A warning indicates conditions or actions that may pose hazards to the user, or cause damage to the meter or equipment under test.







This meter complies with IEC/EN61010-1, 61010-2-032, EN61326-1, double insulation, CAT II 600V, CAT III 300V and pollution grade II safety standards.

Please use the meter only as specified in this manual, otherwise the protection provided by the meter may be impaired.

- 1) Check the clamp meter and the test leads before use. Do not use the meter if the test leads, insulation layer of the case appear damaged, or if there is no display on the screen, or if you suspect that the meter is not operating properly.
- 2) Do not use the meter if the rear cover or the battery cover are not covered up or it will pose a shock hazard.
- 3) Keep the fingers behind the finger guard during operation. Do not touch the bare wires, connectors, unused input terminals or the circuits being measured to prevent electric shock.

- 4) Switch the functional dial to the correct position before measuring. It is strictly forbidden to switch the dial when measuring to avoid damage to the meter.
 - 5) Do not input >600V AC/DC voltage between meter terminal and ground to avoid electric shock and damage to the meter.
 - 6) When measuring AC/DC voltage >30V, please operate carefully according to this user manual or it may pose a shock hazard.
 - 7) Do not measure voltage or current which is higher than the rated value. If the measuring range is unknown, please switch the functional dial to the maximum range. Before measuring the resistance, diode or continuity on line, switch off the power supply of the circuit and fully discharge all capacitors, otherwise the measurement result might be incorrect.
 - 8) To ensure accuracy, replace the battery in time when "  " appears on the screen. Take out the batteries if the meter is not used for a long time.
 - 9) Do not change the internal wiring of the meter to avoid damage to the meter and personal injury.
 - 10) Do not use or store the meter in high temperature, high humidity, flammable, explosive and strong electromagnetic environments.
- Clean the case with a soft cloth and mild detergent. Do not use abrasives or solvents to prevent corrosion and to avoid damage to the meter and personal injury.

4. Electrical Symbols

Symbol	Description	Symbol	Description
	High voltage hazard		Double insulation
	AC		Grounding
	DC		Warning
	Conforms to European Union standards		

5. General Specifications

- LCD display: 4099 max
- Polarity display: auto positive and negative polarity display
- Overload display: "OL" or "-OL"
- Low battery indication: "  " symbol appears, please replace with new batteries.
- Measurement deviation: if the conductor being measured is not placed in the center of the jaw during current measurement, it will cause extra $\pm 1.0\%$ reading error.
- Drop test: 1m drop test passed
- Max jaw opening: 28 mm diameter
- Max current conductor size: 28mm diameter
- Power supply: AAA 1.5V battery x2

- Auto power off: The meter will automatically shut down if the dial is not switched or the buttons are not pressed in about 15 minutes. This function can be turned off as required.
- Dimension: 220mm×77mm×29.5mm
- Weight: about 272g (including batteries)
- Altitude: 2000m
- Operating temperature and humidity: 0°C~30°C (≤80%RH), 30°C~40°C (≤75%RH), 40°C~50°C (≤45%RH)
- Storage temperature and humidity: -20°C~+60°C (≤80%RH)
- EMC:
 RF field (1V/m): overall accuracy = specified accuracy + 5% of range
 RF field (>1V/m): no specified calculation

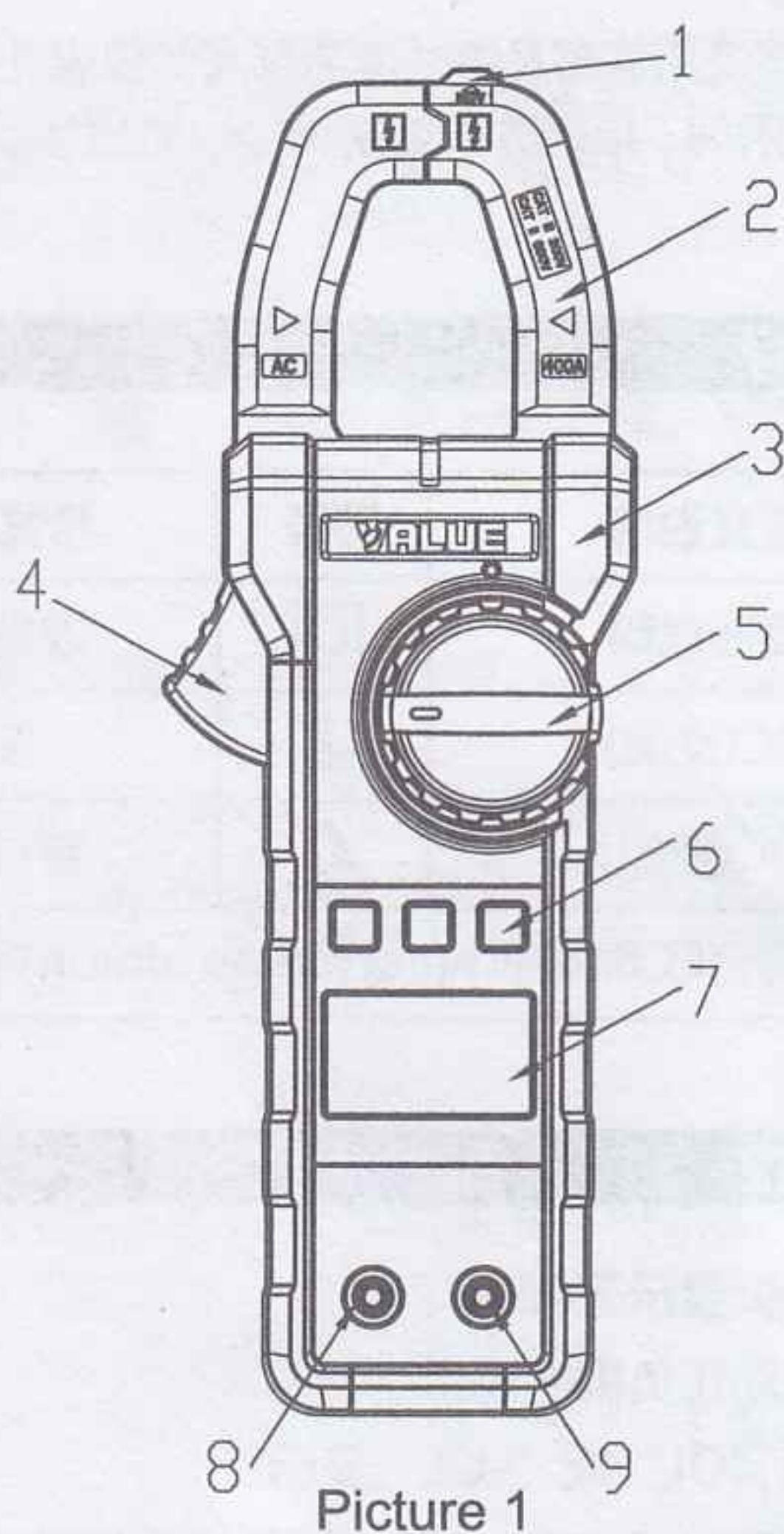

Picture 1

6. External Structure (picture 1)

- 1) NCV sensing part
- 2) Jaws: AC current sensor
- 3) Hand guards: protect user's hand from touching the dangerous area.
- 4) Trigger: press the trigger to open the jaws; release the trigger and the jaws will close automatically.
- 5) Functional dial: select functions
- 6) Functional buttons: select/switch functions or modes
- 7) LCD display: displays measured data and symbols.
- 8) Common input terminal (COM): connects the black test lead or the negative end of the temperature probe.
- 9) Signal input terminal: connects the red test lead or the positive end of the temperature probe.

7. LCD Display (picture 2)

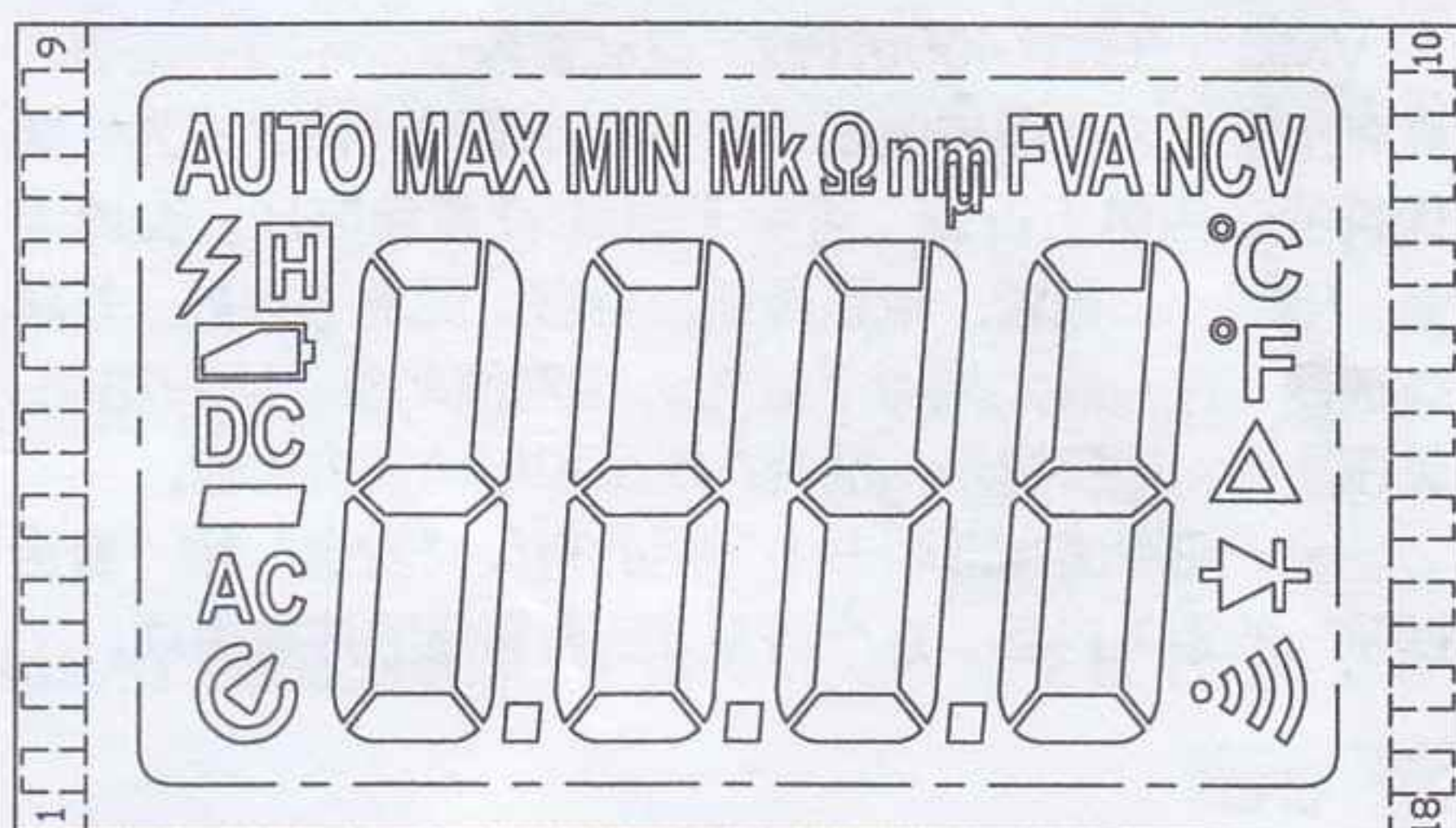

Picture 2 NMC1/VMC-1 LCD display

1	AUTO	Auto range
2	MAX MIN	MAX/MIN measurement
3	MK Ω nµ FVA	Unit
4	NCV	Non-contact AC voltage sensing
5	°C °F	Temperature unit
6	△	Relative value indicator
7	⚡	Diode
8	🔔	Continuity measurement
9	🔄	Auto power off
10	AC	AC signal
11	▭	Negative indicator
12	DC	DC signal
13	🔋	Low battery indicator
14	H	Data hold
15	⚡	High voltage indicator

8. Button Function

1) SELECT/REL:

- In a position with multiple functions, press SELECT/REL to switch between different functions.
- In capacitance position, press SELECT/REL to enter the relative value measurement mode.

2) HOLD/BACKLIGHT:

- Short press to enter/exit the data hold mode.
- Long press to turn on/off the backlight (within 15s). The backlight will be off automatically after 15 seconds while it is enabled.

3) MAX/MIN:

Press once to enter the MAX measurement mode, LCD will display "MAX" symbol. Press the button again to enter the MIN measurement mode, LCD will display "MIN" symbol, and so on.

Long press this button to exit MAX/MIN measurement.

This function is valid only in AC/DC voltage, AC current, resistance and temperature measurement.

9. Technical Index

Accuracy: \pm (% of reading + digits), please perform calibration once a year.

Ambient temperature and humidity: $23^{\circ}\text{C} \pm 5^{\circ}\text{C}$; $\leq 80\% \text{RH}$.

To ensure accuracy, the operating temperature should be within $18^{\circ}\text{C} \sim 28^{\circ}\text{C}$ and the fluctuation range should be within $\pm 1^{\circ}\text{C}$.

Temperature $< 18^{\circ}\text{C}$ or $> 28^{\circ}\text{C}$: add temperature coefficient error $0.1 \times$ (specified accuracy) $/^{\circ}\text{C}$.

9.1 AC Current

Range	Resolution	Accuracy	Overload protection
4.000A	0.001A	$\pm(4\%+20)$	400A
40.00A	0.01A	$\pm(3\%+20)$	
400.0A	0.1A	$\pm(2.0\%+10)$	

- Frequency response: 50Hz~60Hz
- 4A range: open circuit allows least significant digit < 5 .
- Accuracy guarantee range: 5~100% of range

9.2 AC Voltage

Range	Resolution	Accuracy	Overload protection
4.000V	0.001V	$\pm(0.7\%+5)$	600V Vrms
40.00V	0.01V	$\pm(1.0\%+3)$	
400.0V	0.1V		
600V	1V		

- Input impedance $\geq 10\text{M}\Omega$
- Frequency response: 40~400Hz
- Accuracy guarantee range: 5~100% of range

9.3 DC Voltage

Range	Resolution	Accuracy	Overload protection
400.0mV	0.1mV	$\pm(0.7\%+3)$	600V Vrms
4.000V	0.001V	$\pm(0.5\%+2)$	
40.00V	0.01V	$\pm(0.7\%+3)$	
400.0V	0.1V		
600V	1V		

- Input impedance $\geq 10\text{M}\Omega$
- mV range: short circuit allows ≤ 5 digits. Other ranges: return to zero when short-circuited.
- Accuracy guarantee range: 1~100% of range

9.4 Resistance

Range	Resolution	Accuracy	Overload protection
400.0Ω	0.1Ω	±(1.0%+2)	600V Vrms
4.000kΩ	0.001kΩ	±(0.8%+2)	
40.00kΩ	0.01kΩ		
400.0kΩ	0.1kΩ		
4.000MΩ	0.001MΩ	±(2.5%+5)	
40.00MΩ	0.01MΩ		

9.5 Continuity

Range	Resolution	Accuracy	Overload protection
400.0Ω	0.1Ω	≤10Ω buzzer on	600V Vrms
		≥50Ω buzzer off	
		Open circuit voltage: about 2.0V	

9.6 Diode

Range	Resolution	Accuracy	Overload protection
4.000V	0.001V	Open circuit voltage: about 2.2V. Can measure PN junction about ≤2V (forward voltage drop). Silicon PN junction normal voltage: about 0.5~0.8V	600V Vrms

9.7 Capacitance

Range	Resolution	Accuracy	Overload protection
4.000nF	0.001nF	±(4.0%+10)	600V Vrms
40.00nF	0.01nF		
400.0nF	0.1nF	±(4.0%+5)	
4.000uF	0.001uF		
40.00uF	0.01uF		
400.0uF	0.1uF		
4.000mF	0.001mF	±(10%)	

- Measurement result = reading of capacitance – reading of open test leads
(Measured capacitance ≤100nF: REL mode is recommended)
- There is a residual reading (intrinsic capacitance) in open circuit.

9.8 Temperature

Range	Resolution	Accuracy	Overload protection
-40°C~40°C	1°C	±4°C	600V Vrms
40°C~400°C		±(1.5%+5)	
400°C~1000°C		±(2.0%+5)	
-40°F~104°F	1°F	±6°F	
104°F~752°F		±(2.0%+6)	
752°F~1832°F		±(2.5%+4)	

9.9 NCV

Range	Non-contact electric field sensing condition	Accuracy
NCV	Power frequency voltage: about 100V (50Hz/60Hz)	1. Press SELECT to switch to NCV function. 2. Place the NCV sensing part on the clamp head near the measured object (about $\leq 15\text{mm}$). If the measured electric field voltage is $\leq 42\text{V}$, LCD will display "EF". If $> 100\text{V}$, LCD will display segments such as "-" or "- - - -". According to the intensity of the electric field, the buzzer beeps and the red LED flashes with varied frequencies. The higher the electric field intensity, the higher the buzzer frequency, and the higher the red LED flashing frequency. 16mm~80mm: buzzer on or off. $> 80\text{mm}$: buzzer off.

10. Operation Instructions

10.1 AC Current Measurement (picture 3)

- 1) Select AC current range (4A~, 40A~/400A~)
- 2) Open the jaws and place the wire in the center (single wire), make sure the jaws are completely closed and there is no gap between them.
- 3) The meter can only measure one current conductor at a time. If two or more current conductors are measured at the same time, the readings are wrong.

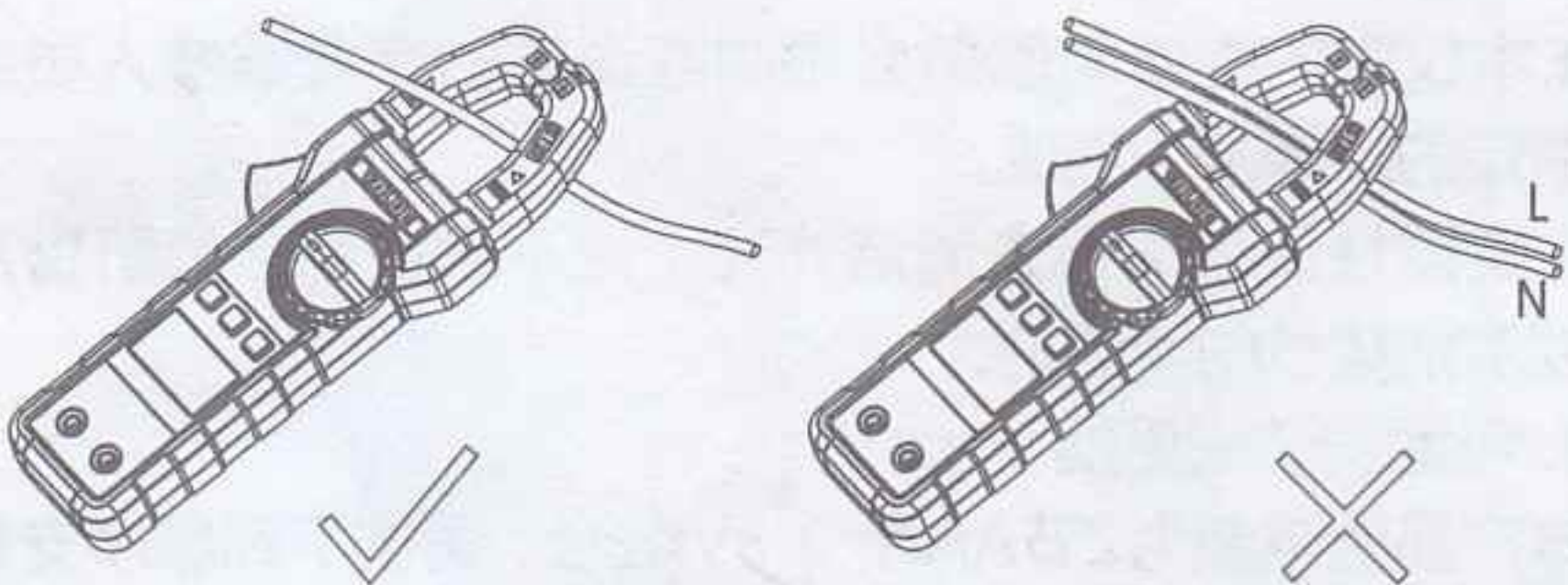

Picture 3

! Notes:

- The current measurement must be operated between $0^{\circ}\text{C} \sim 40^{\circ}\text{C}$. Hold the trigger and do not release it suddenly. The meter is very sensitive to mechanical stress. Any impact will cause change to the reading in a short time.
- To ensure accurate measurement result, place the conductor being measured in the center of the jaw, otherwise it will cause extra $\pm 1.0\%$ reading error.
- Measured current \geq AC 400A: The meter will alarm automatically and the high voltage warning symbol "⚡" will flash automatically.
- Measured current $>$ 420A (max): If "OL" appears, stop testing and use a meter with larger range to measure, or it may cause damage to the meter.

10.2 AC/DC Voltage Measurement

- 1) Insert the red test lead to the "signal input" terminal, black to "COM" terminal.
- 2) Switch the dial to AC voltage position, and connect the test probes with the source or the load in parallel.

Notes:

- Do not input voltage higher than AC 600V. It is possible to measure higher voltage. However, it may cause damage to the meter.
- Be cautious to avoid electric shock when measuring high voltage.
- Measured voltage $\geq 30V/AC$ (safe voltage): The high voltage warning symbol "⚡" will appear on LCD.
- Measured voltage $\geq 600V/AC$: The meter will alarm automatically and the high voltage warning symbol "⚡" will flash automatically.



10.3 Resistance Measurement

- 1) Insert the red test lead to the "signal input" terminal, black to "COM" terminal.
- 2) Switch the dial to " Ω " position and press SELECT to select resistance measurement, then connect the test probes with the resistor in parallel.

Notes:

- If the measured resistor is open or the resistance exceeds the maximum range, the "OL" symbol will appear on the screen.
- Before measuring the resistance on line, switch off the power supply of the circuit, and fully discharge all capacitors.
- If the resistance is greater than 0.5Ω when the test leads are shorted, please check if the test leads are loose or damaged.
- Do not input voltage higher than DC/AC 30V to avoid personal injury.

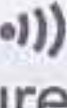
10.4 Continuity Measurement



- 1) Insert the red test lead to the "signal input" terminal, black to "COM" terminal.
 - 2) Switch the dial to "" position and press SELECT to select continuity measurement "", then connect the test probes with the loads in parallel.
- Measured resistance $< 10\Omega$: good conduction circuit, buzzer on (beeps continuously)
- Measured resistance $\geq 10\Omega$ and $\leq 50\Omega$: buzzer on or off
- Measured resistance $> 50\Omega$: buzzer off

Notes:

- Before checking the continuity on line, switch off the power supply of the circuit, and fully discharge all capacitors.
- Continuity measurement: The open circuit voltage is about 2.0V and the range should be 400Ω .
- Do not input voltage higher than DC/AC 30V to avoid personal injury.

10.5 Diode Measurement

1) Insert the red test lead to the "signal input" terminal, black to "COM" terminal. The polarity of the red test lead should be "+" and the polarity of the black test lead should be "-".

2) Switch the dial to "  " position and press SELECT to select diode measurement "  ", then read the forward PN junction voltage of the measured diode on the LCD.

Silicon PN junction: about 500~800mV (normal value).

Notes:

- If the diode is open or its polarity is reversed, "OL" symbol will appear.
- Before measuring the diode on line, switch off the power supply of the circuit, and fully discharge all capacitors.
- Open circuit voltage: about >2.2V
- Do not input voltage higher than DC/AC 30V to avoid personal injury.

10.6 Capacitance Measurement

1) Insert the red test lead to "signal input" terminal, black to "COM" terminal.

2) Switch the dial to "  " position and connect the test probes with the capacitor in parallel.

Measured capacitance $\leq 100\text{nF}$: It is recommended to measure in "REL" mode.

3) It is recommended to use short test leads for capacitance measurement to reduce the effect of distributed capacitance.

Notes:

- If the measured capacitor is short-circuited or the capacitance exceeds the maximum range, the "OL" symbol will appear on the screen.
- When measuring capacitance $>400\mu\text{F}$, it may take some time to obtain steady and accurate readings.
- To ensure measurement accuracy, please fully discharge all capacitors before measuring (especially for capacitors with high voltage) to avoid damage to the meter and personal injury.

10.7 Temperature Measurement

1) Insert the positive temperature probe to the "signal input" terminal, negative to "COM" terminal.

2) Switch the dial to "°C °F" position, LCD will display OL symbol. Short circuit the test probes to read the room temperature.

3) Attach the temperature probe to the surface of the measured object, read its temperature value from the LCD display after a few seconds.

4) Press SELECT button to switch between °F and °C

! Notes:

- The ambient temperature must not exceed 18-28°C, otherwise it will cause measurement error.
- The positive and negative poles of the temperature probe should be correctly connected to the meter. Do not measure non-insulated live objects to prevent error reading.
- Do not input voltage higher than DC/AC 30V to avoid personal injury.

10.8 Non-contact AC Voltage Sensing (NCV, picture 4)

When the electric field is $\geq 100\text{V AC } 50\text{Hz}/60\text{Hz}$, and the NCV sensing part on the clamp head is close to it (about $\leq 15\text{mm}$), the buzzer will keep beeping and the red LED will flash, along with "N" segments appear on the LCD.

According to the intensity of the electric field, the buzzer beeps and the red LED flashes with varied frequencies. The higher the electric field intensity, the higher the buzzer frequency, and the higher the red LED flashing frequency.
16mm~80mm: buzzer on or off. >80mm: buzzer off.

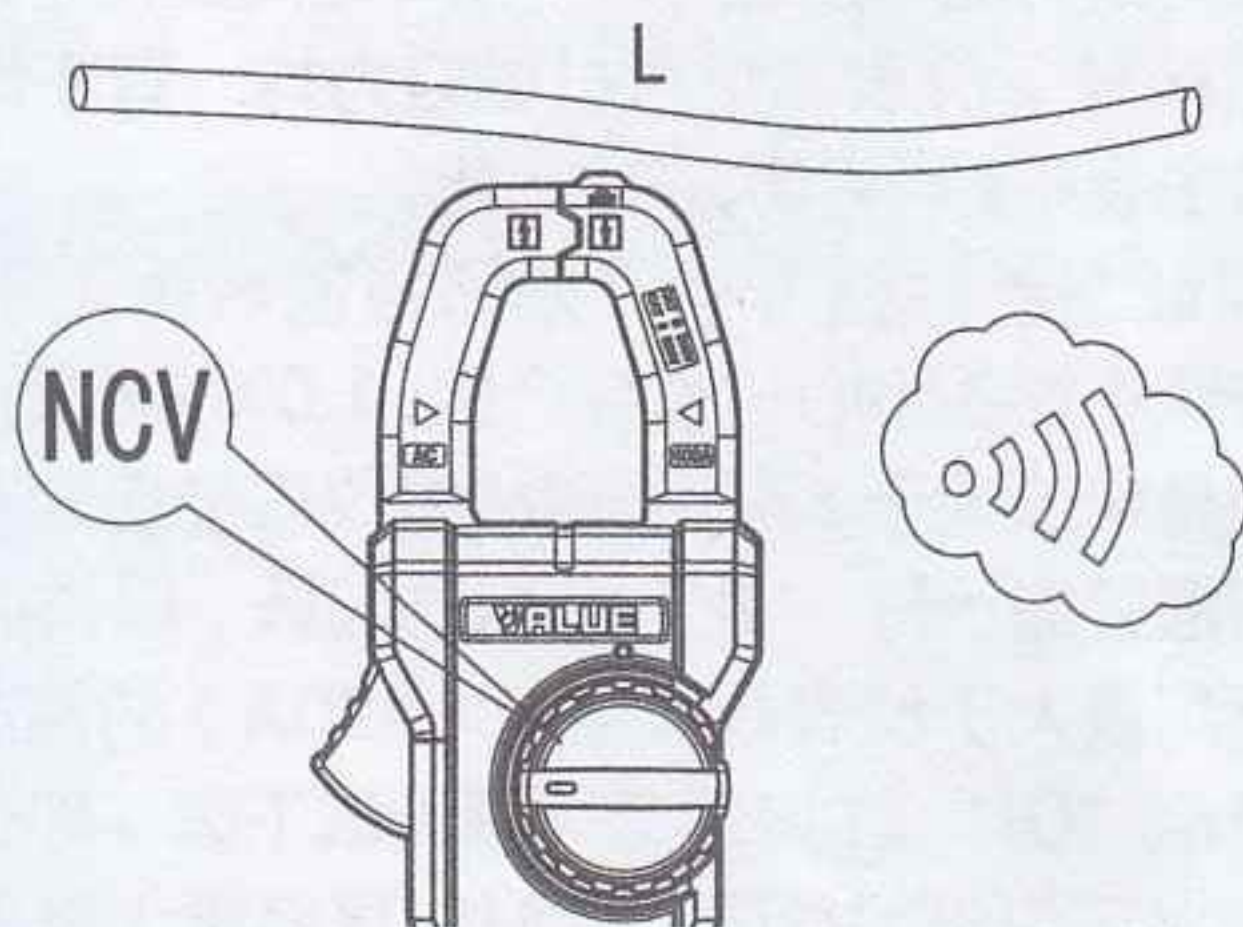

Picture4

! Notes:

- Place the NCV sensing part on the clamp head near the measured electric field, otherwise the measurement sensitivity might be affected.
- Measured electric field $\geq 100\text{V AC}$: pay attention to the insulation of the conductor in the electric field to avoid personal injury.

10.9 Others

- Auto power off: If there is no operation for 15 minutes, the meter will automatically shut down to save power. You can wake up the meter by pressing any button, or switch the dial to OFF and then restart the meter.
- To disable auto power off, switch the dial to OFF position, press the SELECT button and turn on the meter. You can restart the meter to restore the auto power off function.
- Buzzer: The buzzer will make a "beep" sound (about 0.25s) at any valid press or switch of the dial. When measuring voltage or current, the buzzer will also make intermittent "beep" sounds indicating over-range, as follows:
 - a) AC/DC voltage measurement > about 600V
 - b) AC/DC current measurement >400A

- Low battery detection: The meter will detect the internal VDD while working. If the voltage is $<2.5V$, the low battery symbol “” will appear on the LCD.

11. Maintenance (picture 5)

Warning:

Please remove the test leads before opening the bottom cover to avoid electric shock.
Turn the meter OFF when it is not in use.

11.1 General Maintenance

- The maintenance and service must be implemented by qualified professionals or designated departments.
- Periodically clean the case with a dry cloth. Do not use detergents containing abrasives or solvents.

11.2 Battery Installation and Replacement

Power supply: AAA 1.5V battery x 2

- Turn off the meter and remove the test leads from the input terminals.
- Place the meter panel downward and loose the screw on the battery cover, remove the cover and replace the batteries according to the polarity indication.
- Please replace the batteries with the same specifications.
- After installing the new batteries, close the battery cover and tighten the screw.

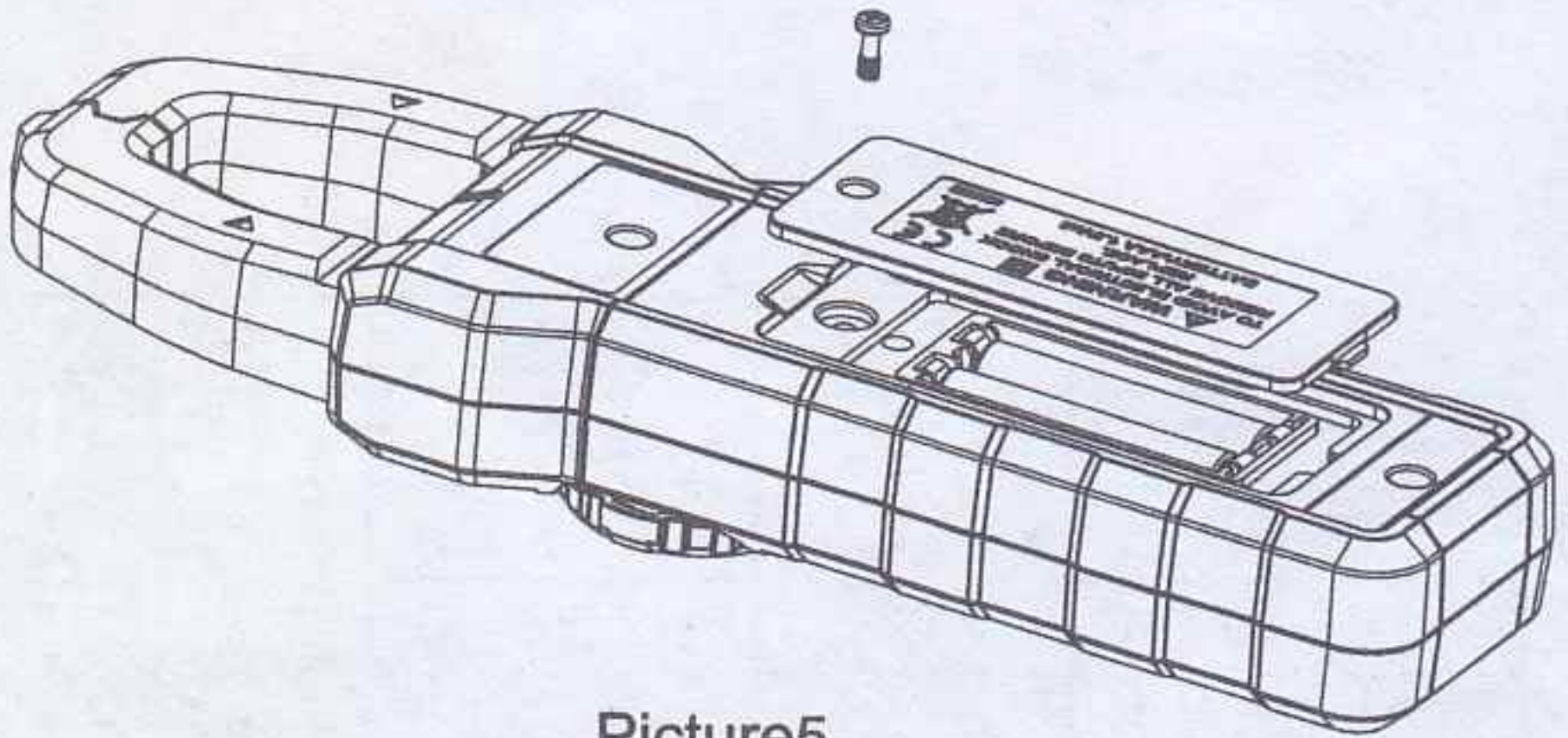

Picture5



VALUE Mechanical & Electrical Products CO., LTD

Add: Jiulong Avenue, Western Industrial District, Wenling, Zhejiang, China

Tel: +86-576-86191959

Fax: +86-576-86191957

Email: value@worldvalue.cn

www.worldvalue.cn